



Catalogus &
Prijsljst
04-2026
DOC0110

Prijzen excl.
BTW.Prijs-
wijzigingen
voorbehou-
den.

Catalogue &
Liste de prix
04-2026

Prix hors TVA.
Sous réserve
des
changements
des prix.

Prices excl.
VAT.
Price changes
reserved.

LAYHER ONDERDELEN ROLSTEIGERS LAYHER ÉLEMENTS ÉCHAFAUDAGES ROULANTS

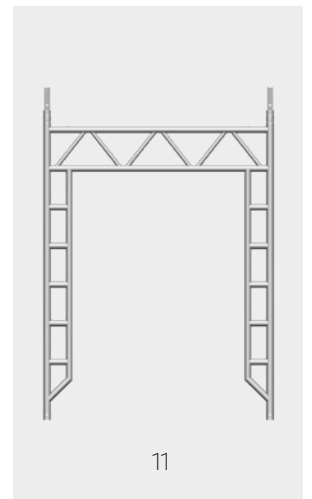
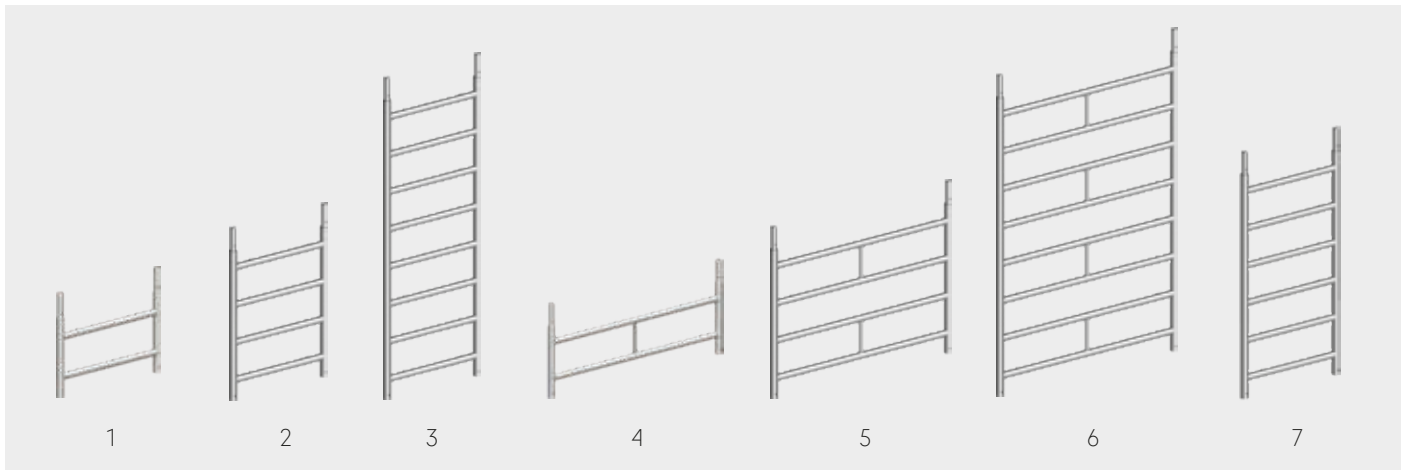







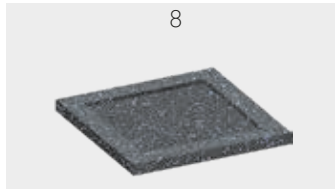
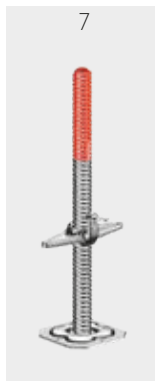
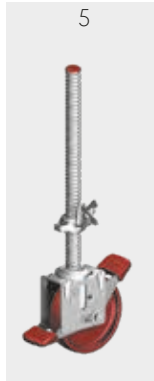
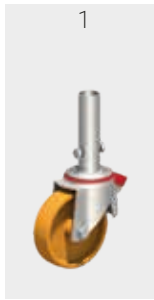

Standelementen / Cadres

Pos.	Omschrijving Désignation	Afmetingen / Dimensions L [m] x B [m] x H [m]	Gewicht Poids [kg]	VE [St.]	Artikelnr. No. d'article	Stuksprijs [€] Prix unitaire
1	Standelement aluminium 75, 2 sporten met anti-slipprofiel Cadre en aluminium 75, 2 échelles avec profil antidérapant Ladder frame aluminum 75, 2 rungs with anti-slip profile	0.75 0.50	2.7		1297/002	83,70
2	Standelement aluminium 75, 4 sporten met anti-slipprofiel Cadre en aluminium 75, 4 échelles avec profil antidérapant Ladder frame aluminum 75, 4 rungs with anti-slip profile	0.75 1.00	4.7		1297/004	135,40
3	Standelement aluminium 75, 8 sporten met anti-slipprofiel Cadre en aluminium 75, 8 échelles avec profil antidérapant Ladder frame aluminum 75, 8 rungs with anti-slip profile	0.75 2.00	8.6		1297/008	243,40
4	Standelement aluminium 150, 2 sporten met anti-slipprofiel Cadre en aluminium 150, 2 échelles avec profil antidérapant Ladder frame aluminum 150, 2 rungs with anti-slip profile	1.50 0.50	3,7		1299/002	122,30
5	Standelement aluminium 150, 4 sporten met anti-slipprofiel Cadre en aluminium 150, 4 échelles avec profil antidérapant Ladder frame aluminum 150, 4 rungs with anti-slip profile	1.50 1.00	7.0		1299/004	190,60
6	Standelement aluminium 150, 8 sporten met anti-slipprofiel Cadre en aluminium 150, 8 échelles avec profil an- tidérapant Ladder frame aluminum 150, 8 rungs with anti-slip profile	1.50 2.00	13.5		1299/008	345,10
7	Standelement aluminium ZIFA, 6 sporten met anti-slipprofiel Cadre en aluminium ZIFA, 6 échelles avec profil antidérapant Ladder frame aluminum ZIFA 6 rungs with anti-slip profile	0.75 1.50	6.9		6491/339	170,40
8	Zifa basiselement 75/6 aluminium zonder wielen Cadre Zifa 75/6 en aluminium sans galets Zifa basic tower 75/6 aluminum without castors	0.75 1.50	20.2		1300/006	432,90
	Zifa basiselement 75/6 aluminium met wielen Cadre Zifa 75/6 en aluminium avec galets Zifa basic tower 75/6 aluminum with castors	0.75 1.50	28.9		1301/006	712,74
9	Zifa basiselement 150/6 aluminium zonder wielen Cadre Zifa 150/6 en aluminium sans galets Zifa basic tower 150/6 aluminum without castors	1.50 1.50	25,12		1315/006	556,40
10	Doorloop standelement aluminium 75/8 sporten. Trapkit. Portique en aluminium 75/8 échelles. Kit escalier. Aluminium gantry ladder frame 75/8 rungs. Stairkit	0.75 2.00	10.1		1296/008	418,70
11	Doorloopstandelement aluminium 150/80 Cadre de passage en aluminium 150/80 Passage frame aluminium 150/80	1.50 2.00	11.5		0704/465	540,20

Wielen / Galets



Pos.	Omschrijving Désignation	Afmetingen / Dimensions L [m] x B [m] x H [m]		Gewicht Poids [kg]	VE [St.]	Artikelnr. No. d'article	Stuksprijs [€] Prix unitaire
1	Zwenkwiel Zifa 400 kg oranje met rem ø 150 mm met bout + moer Galet Zifa 400 kg orange ø 150 mm Castor Zifa 400 kg orange with break ø 150 mm			1.9		1408/150 	69,00
2	Zwenkwiel Zifa 400 kg rubber met rem ø 150 mm met bout + moer Galet Zifa 400 kg en caoutchouc avec frein ø 150 mm avec bouillon et écrou Castor Zifa 400 kg rubber with break ø 150 mm with bolt and nut			2.4		1303/150 	87,80
3	Zwenkwiel SoloTower 400 kg ø 150 mm Galet SoloTower 400 kg ø 150 mm Castor SoloTower 400 kg ø 150 mm			3.9		1300/150 	84,20
4	Zwenkwiel 700 kg ø 200 mm, spindelbereik 0.30-0.60 m Galet réglable 700 kg ø 200 mm gamme de broche 0.30-0.60 m Castor 700 kg ø 200 mm, adjustment rage 0.30-0.60 m			6.8		1359/200 	117,50
5	Zwenkwiel 1000 kg ø 200 mm, spindelbereik 0.30-0.60 m Galet réglable 1000 kg ø 200 mm gamme de broche 0.30-0.60 m Castor 1000 kg ø 200 mm adjustment rage 0.30-0.60 m			6.3		1260/201 	169,80
6	Zwenkwiel halve kopp. 1200 kg ø 200 mm, spindelber. 0.30-0.60 m Galet réglable avec demi collier 1200 kg ø 200 mm g.d.b. 0.30-0.60 m Castor with half coupler 1200 kg ø 200 mm adjustment rage 0.30-0.60 m			12.0		1267/200 	322,20
7	Voetspindel 0.60 m met borging Socle réglable 0.60 m avec fixation Base plate spindle 0.60 m with locking			3.8		1257/060 	41,50
8	Rubber slof, zwart/blauw Plaque de protection en caoutchouc pour socle réglable, noir/bleu Base plate, rubber, black/blue	0.20	0.20	0.4		9810/013 	5,18

Plattformen / Planchers

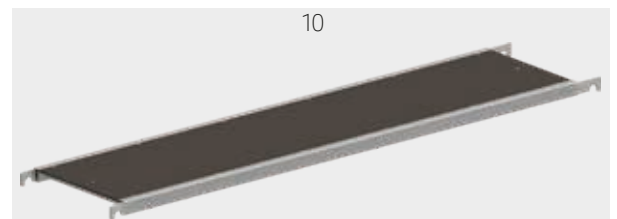
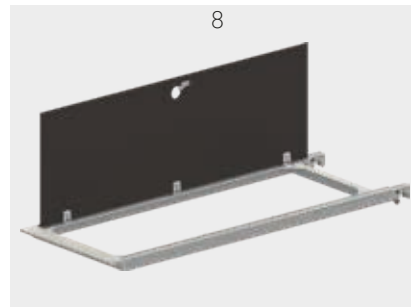
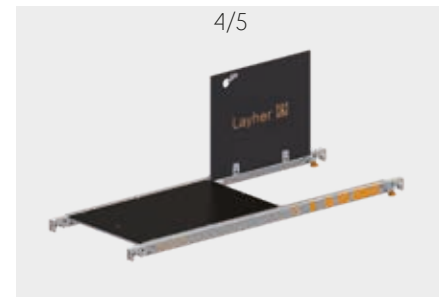
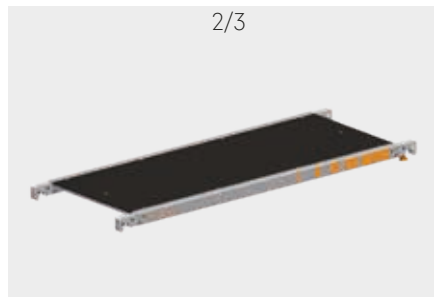
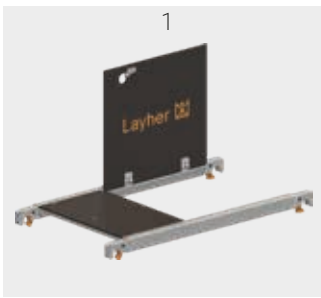

Liggers / Leuningen Lisses / Garde-corps

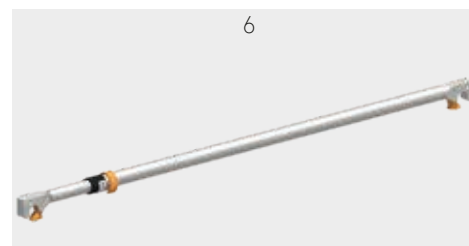
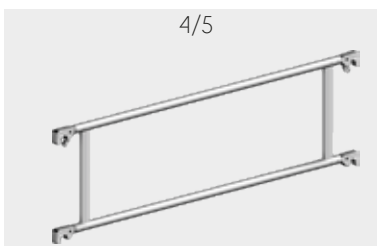
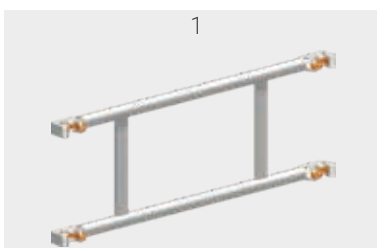

Platformen / Planchers

Pos.	Omschrijving Désignation	Afmetingen / Dimensions L [m] x B [m] x H [m]		Gewicht Poids [kg]	VE [St.]	Artikelnr. No. d'article	Stuksprijs [€] Prix unitaire
1	Passageplatform SoloTower Plancher d'accès, SoloTower Access deck SoloTower	1.13	0.68	11.4		1242/113	243,30
2	Platform BASIC/COMPACT 2 klauwen Plancher BASIC/COMPACT 2 griffes Deck BASIC/COMPACT 2 claws	1.80	0.68	13.3		1441/180	238,30
3	Platform STANDARD/LARGE 2 klauwen Plancher BASIC/COMPACT 2 griffes Deck BASIC/COMPACT 2 claws	2.85	0.68	20.0		1441/285	332,00
4	Platform met luik BASIC/COMPACT 2 klauwen Plancher avec trappe BASIC/COMPACT 2 griffes Deck BASIC/COMPACT 2 claws	1.80	0.68	15.0		1442/180	294,00
5	Platform met luik STANDARD/LARGE 2 klauwen Plancher avec trappe STANDARD/LARGE 2 griffes Access Deck STANDARD/LARGE 2 claws	2.85	0.68	21.6		1442/285	369,90
6	Montageplatform rolsteiger Plancher de montage Assembly platform	1.80	0.32	11.6		0727/481	243,30
7	Montageplatform rolsteiger Plancher de montage Assembly platform	2.85	0.32	18.7		0727/482	271,20
8	Passageplatform trap COMPACT Plancher rabattable COMPACT Stairway access deck COMPACT	1.80	0.68	12.2		1243/180	279,20
9	Console tussenvlonder Console plancher intercal. Intermediate deck	2.85	0.23	10.5		1339/285	274,70
10	Doorbouwplatform Plancher de continu Connection platform	2.85	0.68	26.5		0703/570	615,10

Liggers / Leuningen Lisses / Garde-corps

Pos.	Omschrijving Désignation	Afmetingen / Dimensions L [m] x B [m] x H [m]		Gewicht Poids [kg]	VE [St.]	Artikelnr. No. d'article	Stuksprijs [€] Prix unitaire
1	Dubbele leuning aluminium SoloTower Double garde-corps en aluminium SoloTower Double guardrail aluminium SoloTower	1.13	0.50	5.9		1342/113	113,60
2	Ligger/leuning aluminium BASIC/COMPACT Lisse/Garde-corps en aluminium BASIC/COMPACT Guardrail/ledger aluminium BASIC/COMPACT	1.80		2.3		1205/180	58,70
3	Ligger/leuning aluminium STANDARD/LARGE Lisse/Garde-corps en aluminium STANDARD/LARGE Guardrail/ledger aluminium STANDARD/LARGE	2.85		3.6		1205/285	67,70
4	Dubbele leuning aluminium BASIC/COMPACT Double garde-corps en aluminium BASIC/COMPACT Double guardrail aluminium BASIC/COMPACT	1.80	0.50	5.8		1206/180	150,60
5	Dubbele leuning aluminium STANDARD/LARGE Double garde-corps en aluminium STANDARD/LARGE Double guardrail aluminium STANDARD/LARGE	2.85	0.50	8.0		1206/285	184,60
6	Teleleuning UNI P2, aluminium Tele garde-corps en aluminium UNI P2 Tele guardrail, aluminium UNI P2	1.80-2.85		3.9		1204/180	153,80
7	Leuningstaander aluminium 2 sporten Poteau garde-corps en aluminium 2 echelles Guardrail post aluminum 2 rungs	1.00		1.8		1297/100	45,90

Diagonalen / Diagonales

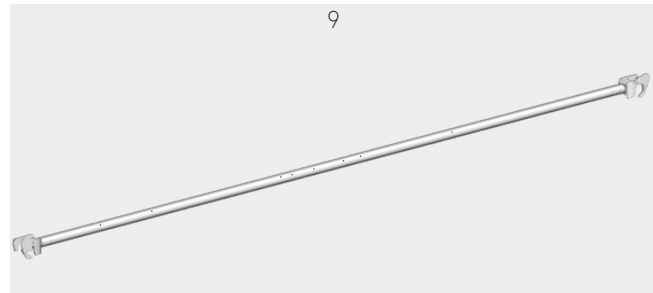
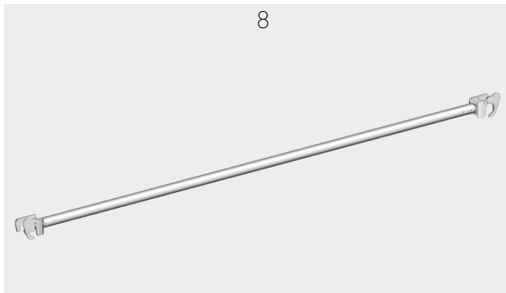
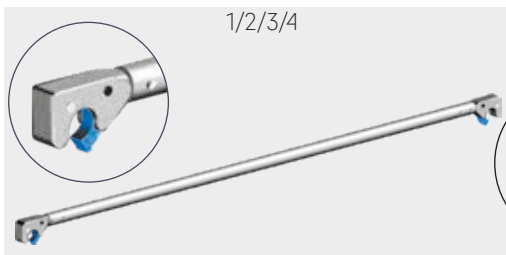

Kantplanken / Plinthes

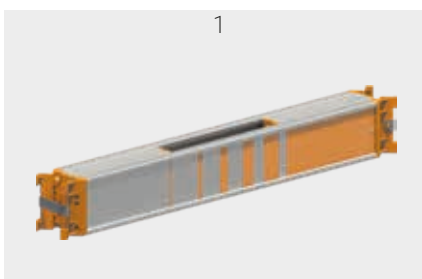

Diagonalen / Diagonales

Pos.	Omschrijving Désignation	Afmetingen / Dimensions L [m] x B [m] x H [m]	Gewicht Poids [kg]	VE [St.]	Artikelnr. No. d'article	Stuksprijs [€] Prix unitaire
1	Diagonaal BASIC/COMPACT 4 sporten Diagonale BASIC/COMPACT 4 échelles Diagonal brace BASIC/COMPACT 4 rungs	1.95 1.80 0.75	2.8		1208/195 📦	56,00
2	Diagonaal BASIC/COMPACT 8 sporten Diagonale BASIC/COMPACT 8 échelles Diagonal brace BASIC/COMPACT 8 rungs	2.50 1.80 1.75	3.3		1208/180 📦	62,70
3	Diagonaal STANDARD/LARGE 4 sporten Diagonale STANDARD/LARGE 4 échelles Diagonal brace STANDARD/LARGE 4 rungs	2.95 2.85 0.75	3.8		1208/295 📦	68,70
4	Diagonaal STANDARD/LARGE 8 sporten Diagonale STANDARD/LARGE 8 échelles Diagonal brace STANDARD/LARGE 8 rungs	3.35 2.85 1.75	4.1		1208/285 📦	73,30
5	Horizontale diagonaal BASIC Diagonale horizontale BASIC Horizontal diagonal brace BASIC	1.80 0.75	3.5		1209/180 🕒	70,50
6	Horizontale diagonaal STANDARD Diagonale horizontale STANDARD Horizontal diagonal brace STANDARD	2.85 0.75	4.6		1209/285 🕒	89,30
7	Montageplatform rolsteiger Horizontale diagonaal LARGE Diagonale horizontale LARGE Horizontal diagonal brace LARGE	2.85 1.50	6.0		1210/285 📦	97,30
8	Platformdiagonaal, aluminium Diagonale de la plate-forme en aluminium Platform diagonal, aluminium	2.50	4.2		1347/250 🕒	115,40
9	Platformdiagonaal, aluminium Diagonale de la plate-forme en aluminium Platform diagonal, aluminium	3.35	5.0		1347/335 🕒	128,60

Kantplanken / Plinthes

Pos.	Omschrijving Désignation	Afmetingen / Dimensions L [m] x B [m] x H [m]	Gewicht Poids [kg]	VE [St.]	Artikelnr. No. d'article	Stuksprijs [€] Prix unitaire
1	Kantplankset SoloTower Plinthe echaf. Set Solowtower Toeboard set SoloTower	1.13 0.75 0.15	5.6		1240/113 📦	237,10
2	Kantplank BASIC/COMPACT oranje Plinthe BASIC/COMPACT orange Toe board BASIC/COMPACT orange	1.80 0.15	4.2		1439/180 📦	49,40
3	Kantplank STANDARD/LARGE oranje Plinthe STANDARD/LARGE orange Toe board STANDARD/LARGE orange	2.85 0.15	5.6		1439/285 📦	52,50
4	Kopkantplank BASIC/STANDARD oranje Plinthe de tête BASIC/STANDARD orange End toe board BASIC/STANDARD orange	0.75 0.15	1.6		1438/075 📦	30,80
5	Kopkantplank COMPACT/LARGE oranje Plinthe de tête COMPACT/LARGE orange End toe board COMPACT/LARGE orange	1.44 0.15	2.9		1438/144 📦	31,90
6	Kopkantplank aluminium Plinthe de tête en aluminium End toe board aluminium	0.75 0.15	1.0		9557/075 📦	48,48

Ladders / Escaliers

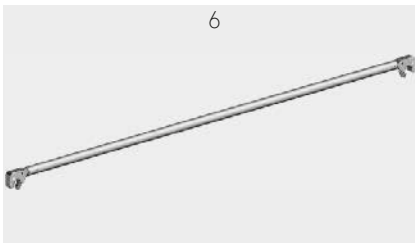
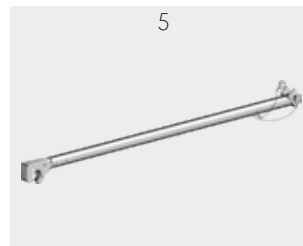
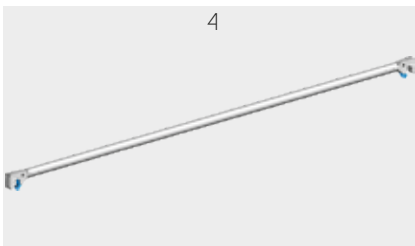
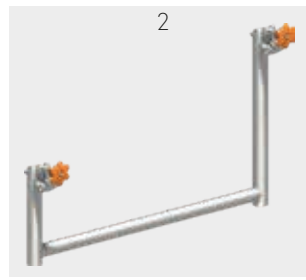

Tralieliggers / Poutres en treillis

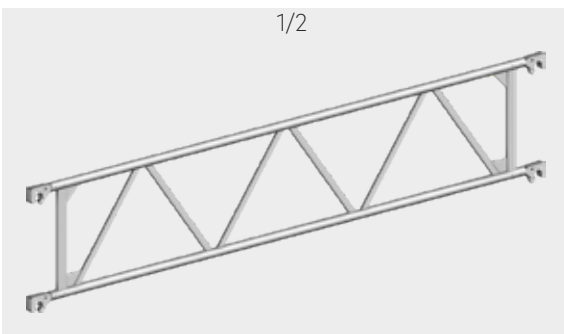

Ladders / Escaliers

Pos.	Omschrijving Désignation	Afmetingen / Dimensions L [m] x B [m] x H [m]			Gewicht Poids [kg]	VE [St.]	Artikelnr. No. d'article	Stuksprijs [€] Prix unitaire
1	Opstapbeugel 0.30 m Etrier de base 0.30 m Acces ledger 0.30 m	0.30			2.9		1344/002	86,00
2	Basisbeugel 0.75 m Etrier de base 0.75 m Acces ledger 0.75 m	0.75			3.3		1344/003	94,20
3	Aluminium trap BASIC/COMPACT Volee escalier en aluminium BASIC/COMPACT Aluminum stairway BASIC/COMPACT	1.80	1.75		15.5		1212/180	453,10
	Aluminium trap LARGE Volee escalier en aluminium LARGE Aluminum stairway LARGE	2.85	1.75		27.8		0737/229	1.214,30
4	Aluminium trapleuning Garde-corps de volée Stairway guardrail aluminum		1.80	1.75	3.8		1213/180	77,20
			2.85	1.75	5.4		0713/063	162,30
5	Aluminium trapleuning Garde-corps de volée Stairway guardrail aluminum	1.20	1.80		1.8		1327/120	77,70
6	Bovenleuning t.b.v. aluminium trap LARGE Garde-corps supérieure pour escalier en alum. LARGE Top guardrail for aluminum stairway LARGE	1.50	2.85	1.75	2.0		0737/231	118,60
7	Inhaakladder 6 sporten t.b.v. 1296/008 Echelle acces pour 1296/008 6 barr. Access ladder for 1296/008 6 rgs.	2.00			2.8		1247/006	104,80

Tralieliggers / Poutres en treillis

Pos.	Omschrijving Désignation	Afmetingen / Dimensions L [m] x B [m] x H [m]			Gewicht Poids [kg]	VE [St.]	Artikelnr. No. d'article	Stuksprijs [€] Prix unitaire
1	Tralieligger BASIC/COMPACT Poutre en treillis BASIC/COMPACT Lattice beam BASIC/COMPACT	1.80	0.50		7.7		1207/180	218,20
2	Tralieligger STANDARD/LARGE Poutre en treillis STANDARD/LARGE Lattice beam STANDARD/LARGE	2.85	0.50		9.6		1207/285	248,20



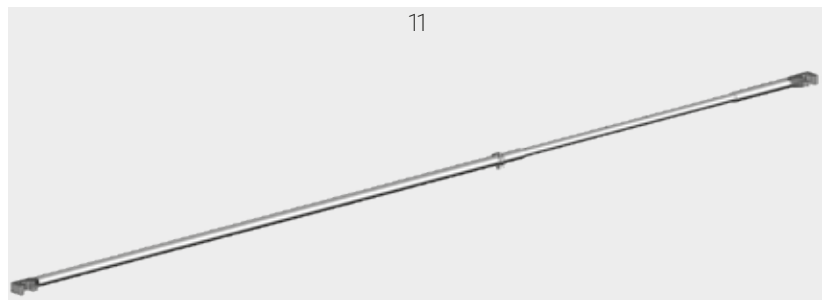
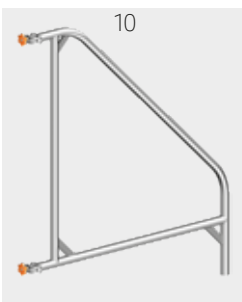
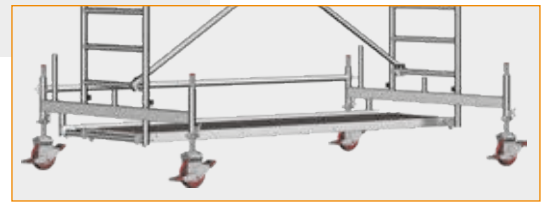
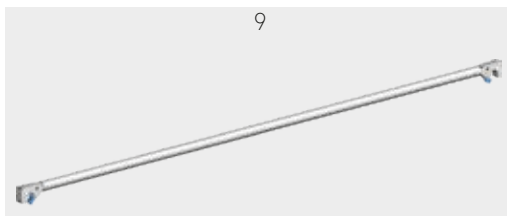
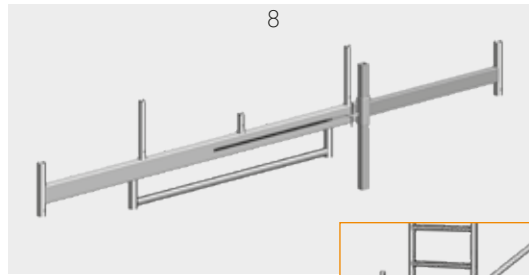
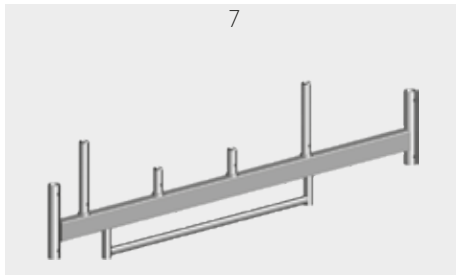
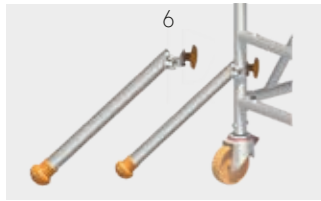







Steunen / Béquilles





Consoles / Consoles



Steunen / Béquilles

Pos.	Omschrijving Désignation	Afmetingen / Dimensions L [m] x B [m] x H [m]	Gewicht Poids [kg]	VE [St.]	Artikelnr. No. d'article	Stuksprijs [€] Prix unitaire
1	Zijsteun verstelbaar SoloTower Béquille réglable SoloTower Stabilizer adjustable SoloTower	1.20-2.00	5,2		1248/000 	169,60
2	Zijsteun vouwbaar Béquille pliable Stabilizer foldable	1.80	4,2		1248/180 	131,90
3	Zijsteun vouwbaar/verstelbaar Béquille pliable ajustable Stabilizer extendable	2.60	8,5		1248/260 	202,80
4	Zijsteun Béquille Stabilizer	5.00	14,9		1248/500 	313,40
5	Verdraaibeveiliging Sécurité de torsion Rotation preventer	0.50	2,8		1248/261 	93,60
6	Zijsteun voor ZIFA 260 en 310, staal Béquille pour ZIFA 260 et 310 en acier Stabilizer for ZIFA 260 and 310, steel	0.42	2,8		0738/318 	37,40
7	Stabilisatiebalk met beugel Embase Mobile beam with bar	1.80	19,9		1323/180 	180,10
8	Stabilisatiebalk met beugel verstelbaar Embase extensible Mobile beam with bar adjustable	2.30- 3.20	42,5		1323/320 	434,10
9	Horizontale diagonaal STANDARD Diagonale horizontale STANDARD Horizontal diagonal brace STANDARD	2.85	4,6		1209/285 	89,30
10	Zijsteun voor zwenkwiel, aluminium Béquille pour galet en aluminium Stabilizer for castor, aluminum		8,2		1216/000 	235,30
11	Horizontale verstelbare diagonaal Diagonale horizontale, ajustable Horizontal diagonal brace, adjustable	3.20-4.00	6,1		1318/000 	141,50

Consoles / Consoles

Pos.	Omschrijving Désignation	Afmetingen / Dimensions L [m] x B [m] x H [m]	Gewicht Poids [kg]	VE [St.]	Artikelnr. No. d'article	Stuksprijs [€] Prix unitaire
1	Uitbouw dakconsole Consoles d'extension sur la pente de toit External roof console	1.50	10,5		0727/547 	558,00
2	Aluminium uitbouwconsole met 2 koppelingen Console en aluminium avec 2 colliers Console bracket aluminium with 2 couplers	0.75 0.90	5,4		1341/075 	229,60

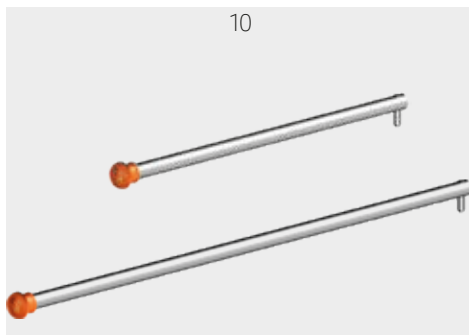
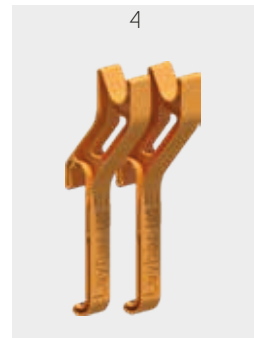
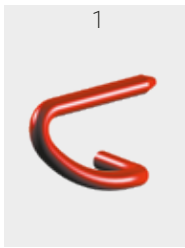

Pos.	Omschrijving Désignation	Afmetingen / Dimensions L [m] x B [m] x H [m]	Gewicht Poids [kg]	VE [St.]	Artikelnr. No. d'article	Stuksprijs [€] Prix unitaire
1	Borgpen, rood Goupille queue de cochon, rouge Locking pin, red		0.15		4000/001	1,50
2	Montagehaak SoloTower (4 stuks) Chrochet de mont. SoloTower (4 pcs) Assembly hook SoloTower (4 pcs)		1.2		1300/002	69,00
3	Montagetas SoloTower Sac de montage SoloTower Mounting bag SoloTower		0.2		1300/003	21,30
4	Rolsteiger Montagehaak P2 (2 Stuks) oranje P2 Crochets de montage P2 (2 pcs) oranje UNI Assembly hook orange T19 (2 pcs)		1.2		1300/010	61,60
5	Rubber dop voor buis 42.3 mm Bouchon en caoutchouc tube 42.3 mm Rubber base for tube 42.3 mm		0.16		6494/940	6,90
6	Rubber dop voor buis 48.3 mm Bouchon en caoutchouc tube 48.3 mm Rubber base for tube 48.3 mm		0.12		1020/000	8,50
7	Wartelmoer Volant pour bequille Star shaped knob		0.05		6491/422	7,20
8	Borgclip Ø48.3 mm Goupille-clip Ø48.3 mm Spring clip Ø48.3 mm		0,1		1250/000	2,40
9	Ballast + halve koppeling 10 kg Ballaste avec demi collier 10 kg Ballast 10 kg with half coupler		10.0		1249/000	87,60
10	Afstandhouder (excl. koppeling) Distanceur excl. collier Distance tube, excl. coupler	0.50	0,6		1275/050	15,90
	Afstandhouder (excl. koppeling) Distanceur excl. collier Distance tube, excl. coupler	1.10	1,4		1275/110	41,20
11	Afstandhouder (excl. koppeling) Distanceur, excl. collier Distance tube, excl. coupler	1.80	2,1		1275/180	52,60
	Uitschuifbare afstandhouder, aluminium Distanceur telescopique, en aluminium Distance tube, extendable, aluminium	1.25 - 1.90	3,0		1275/001	90,10
12	Opstapbeugel verbinder Liaison pr. etrier de base Base strut connector	1.80	6,2		1324/180	90,30
13	Opstapbeugel verbinder Liaison pr. etrier de base Base strut connector	2.85	9,3		1324/285	110,40
14	Kruiskoppeling + 2 wartelmoeren Collier othogonale avec 2 ecrous de serrage Double coupler with 2 hand nuts		1,54		9800/001	28,28
15	Draaikoppeling + 2 wartelmoeren Collier orientable avec 2 ecrous de serrage Swivel coupler with 2 hand nuts		1,70		9800/004	31,67



www.layher.nl/shop/

Layher b.v.
Lissenveld 18
4941 VL Raamsdonksveer, NL

0162-58 68 00
mail@layher.nl
www.layher.nl

Layher n.v./s.a.
Mouterij 6
2550 Kontich, B

015/31 03 39
mail@layher.be
www.layher.be